

# Soleerzeuger B3 4/8m<sup>3</sup>

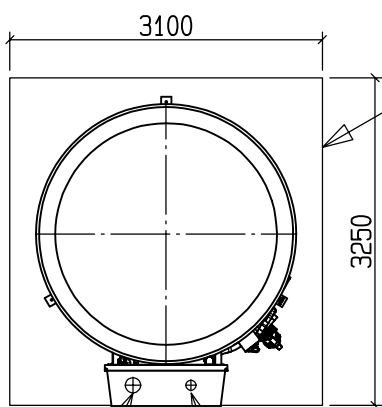
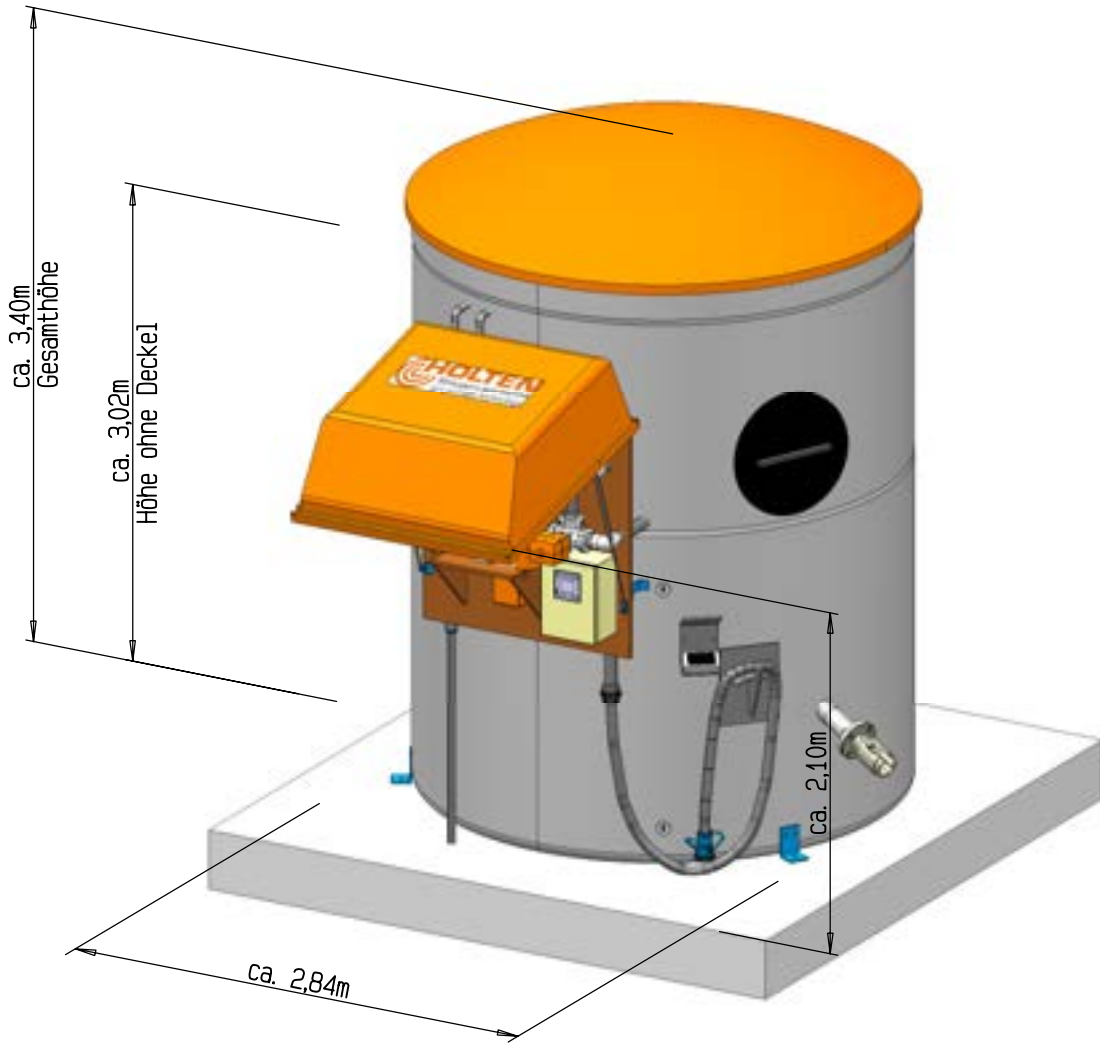

Fundamentplatte  
B/L/H 3,10m/3,25m/0,30m

Salzvorlage 4 m<sup>3</sup>  
Solevorlage 8 m<sup>3</sup>

Abbildung zeigt Sonderzubehör!  
Technische Änderungen vorbehalten

Wasserezuleitung 1½", 4-7bar  
Stromleitung 400V, 16A



D - 83098 Brannenburg  
Tel. +49 (08034)3056-0  
Fax. +49 (08034)305656  
kontakt@holten-gmbh.de